











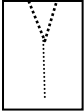
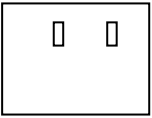
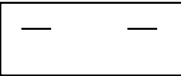
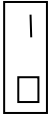
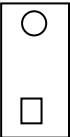



100% reine extrafeine Merinowolle, ÖkoTex Standard 100 zertifiziert, meliert, weicher Griff, verstrickt in Österreich.

	JackenMantel 2-färbig reversibel	€ 230,--
	Jacke "KragenTasche" L 700 mm uni	€ 230,--
	Jacke „Rippe waagrecht“ L 800 mm uni / miteinander	Revers/ StehKragen € 210,-- verdeckte Knopfleiste € 220,--
	Jacke "Rollende Kante" L 900 cm uni / 3-färbig	uni € 200,-- Farbstreifen € 210,--
	MantelCape mit MagnetBrosche L 800 mm 2-färbig reversibel	€ 160,--
	Jacke "Rollende Kante" L 650 mm uni	1-fädig € 130,-- 2-fädig € 150,-- Struktur € 160,--
	V-Jacke uni / miteinander	L 600 mm € 130,-- L 750 mm € 150,-- mit Taschen

	Poncho one size 2-färbig reversibel	€ 130,--
	DreieckPoncho 2-färbig reversibel	€ 95,--
	Rock mit Schlitz oder Zwickel L 700 mm	€ 115,--
	Hose mit 2 Taschen	€ 125,--
	StehKragenKleid „X“ und „A-Form“ L 850 mm uni dick / Struktur 2-färbig	€ 155,--
	V-PullOverKleid V-PullOver mit Rippenärmel uni	L 1000 mm € 135,-- L 850 mm € 125,--
	V-PullOver „Asymmetrie“ mit Rippenärmel L 800 mm uni	€ 130,--
	PoloPullOver L 700 mm uni, Kragen 2-färbig	€ 125,--
	RundHalsPullOver mit angesetzten Ärmel L 800 mm uni / 3-färbig	€ 120,-- Farbstreifen € 130,--

	StehKragenPullOver RollKragenPullOver "Rippe waagrecht" L 750 mm uni	€ 140,--
	StehKragenFernPullOver L 750 mm uni	dünn € 120,-- mit Schlitz: dick € 145,-- Rippe längs € 145,--
	StehKragenPullOver schräger Saum mit Tasche L 650 mm uni	dünn € 120,-- dick € 140,--
	U-BootPullOver mit Rippenärmel uni	L 800 mm € 120,-- L 900 cm € 130,--
	U-BootPullOver „vorerutschte Naht“ „Struktur“ „Rippe waagrecht“ mit angesetzten Ärmel L 700 mm uni	€ 130,--
	U-BootPullOver "FarbenStreifen" mit Rippenärmel L 800 mm 3-färbig	€ 130,--
	U-BootPullOver weit mit Rippenärmel L 800 mm uni, Ärmel 2-färbig	€ 130,--
	PullOver "Rollende Kante" mit Tasche L 650 mm uni	€ 130,--

	StolaJacket „Rippe waagrecht“ uni / miteinander	L 600 mm € 105,- L 800 mm € 145,-
	JackenCape „Asymmetrie“ L 1100 mm Reversibel uni + 2-färbig	€ 120,-
	WestOver 1400 x 700 uni / miteinander 2-färbig	€ 105,-
	Schal mit kleiner Tasche 1800 X 450 mm uni / miteinander 2-färbig	€ 95,-
	EIN LochSchal 2300 x 500 mm uni + 2-färbig reversibel	€ 95,-
	SchlitzStola 2300 x 600 mm uni	€ 95,-
	RippenStola uni / 2-farbig / FarbBlock / FarbenStreifen 2300 x 500 mm	€ 95,-
	SchlaufenSchal 1800 x 300 mm 2-färbig	€ 50,-
	SchlitzSchal 1800 x 300 mm uni	€ 50,-

	RippenSchal uni / 2-färbig / FarbBlock / FarbenStreifen 1800 x 400 mm weit 1800 x 500 mm	€ 50,- weit € 55,-
	RingelSchal 1800 x 300 mm 2-färbig	€ 50,-
	KapuzenSchal längs kurz: 1100 x 300 mm lang: 1800 x 300 mm reversibel 2-färbig	kurz € 55,- lang € 60,-
	RundSchal 750 mm 2-färbig	€ 35,-
	Halskragen PullAround uni / miteinander 2-färbig	groß € 27,- lang € 30,- maxi € 55,-
	BeanieMütze 2-färbig reversibel	€ 30,-
	Stulpen Pulsling uni / 2-färbig	kurz € 19,- lang € 22,-

SCARF Schal

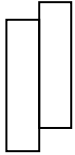
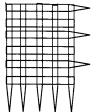

100% Seide mit G.O.T.S. zertifizierter Merinowolle handgefärbt in Wien.

	SchalStola "Wien" 1800 x 600 mm	€ 115,-
	GitterSchal mit Seide Limitierte Auflage 1700 mm	€ 60,-

schau RAUM

FÜR ANGEWANDTE KUNST

siebensterngasse 33
1070 wien
tel *43/1/524 25 02
mobil *43/676/75 76 700
office@schauraum.at
www.schauraum.at
www.austriandesign.at

Preisliste gültig bis 31. März 2022
Price list valid till march, 31st 2022

Prices: All prices are retailer prices per unit exclusive VAT. Retail prices are for professional trader only. Duties, insurance and shipping from Vienna are not included. Schauraum für angewandte Kunst reserves the right to change the prices and specifications without notice. **Terms of delivery:** Ex store Vienna/Austria. Partial deliveries are allowed. **Terms of payment:** All orders have to be pre-paid. Bank fees caused from orders from foreign countries have to be paid by the customer. **Damages & Shortages:** All damages and shortages must be reported within 7 days of receipt of the goods in written form or facsimile. **Quality:** Please do not forget, that all the products are handmade. That's why the pieces may show small irregularities in size, shape, colour or pattern. **Bank Account:** Unicredit Vienna, IBAN AT27 1200 0007 5908 8610, BIC/SWIFT BKAUATWW ATU 45 32 11 01